

## User Manual

**Portable  
Fault Locating System  
EZ-ThumpV3-3/4/12 kV  
all V3 models  
are *MULTI SHOT* only**

Read this entire manual before operating

M

Valley Forge Corporate Center  
2621 Van Buren Avenue  
Norristown, PA 19403-2329  
U.S.A.

610-676-8500

*[www.megger.com](http://www.megger.com)*



**Portable Fault Locating System  
EZ-ThumpV3-3/4/12kV**



Copyright© 2019 by Megger. All rights reserved.

No part of this handbook may be copied by photographic or other means unless Megger have before-hand declared their consent in writing. The content of this handbook is subject to change without notice. Megger cannot be made liable for technical or printing errors or shortcomings of this handbook. Megger also disclaims all responsibility for damage resulting directly or indirectly from the delivery, supply, or use of this matter.

The information presented in this manual is believed to be adequate for the intended use of the product. If the product or its individual instruments are used for purposes other than those specified herein, confirmation of their validity and suitability must be obtained from Megger. Refer to the warranty information below. Specifications are subject to change without notice.

## **WARRANTY**

Products supplied by Megger are warranted against defects in material and workmanship for a period of one year following shipment. Our liability is specifically limited to replacing or repairing, at our option, defective equipment. Equipment returned for repair must be shipped prepaid and insured. Contact your local MEGGER representative for instructions and a return authorization (RA) number. Please indicate all pertinent information, including problem symptoms. Also specify the serial number and the catalog number of the unit. This warranty does not include batteries, lamps or other expendable items, where the original manufacturer's warranty shall apply. We make no other warranty. The warranty is void in the event of abuse (failure to follow recommended operating procedures) or failure by the customer to perform specific maintenance as indicated in this manual.

<b>Local Megger Offices</b>		
<b>Australia</b>	<b>Canada</b>	<b>France</b>
Megger Pty Limited Unit 1, 11-21 Underwood Road Homebush NSW 2140 T: +61 (0)2 9397 5900 F: +61 (0)2 9397 5911	110 Milner Avenue Unit 1 Scarborough Ontario M1S 3R2 Canada  T: 1 416 298 6770 F: 416 298 0848	9 rue Michael Faraday 78180 Montigny-le-Bretonneux T: 01 30 16 08 90 F: 01 34 61 23 77
<b>Germany</b>	<b>India</b>	<b>Kingdom of Bahrain</b>
Megger Germany Dr. Herbert Iann Str. 6 96148 Baunach / Germany  T: +49 9544 680 F: +49 9544 2171	Megger (India) Pvt Limited 501 Crystal Paradise Mall Off. Veera Desai Road Andheri (W) Mumbai 400053 T: +91 22 26740468 F: +91 22 26740465	P.O. Box 15777 Office 81, Building 298 Road 3306, Block 333 Manama Kingdom of Bahrain. T: +973 177 40 620 F: + 973 177 20 975 mesales@megger.com
<b>Kingdom of Saudi Arabia</b>	<b>South Africa</b>	<b>Sweden</b>
PO Box 1168 Khobar 31952  T: +966 3889 4407 F: +966 3889 4077 mesales@megger.com	PO Box 22300 Glen Ashley 4022 Durban South Africa  T: +27 (031) 5646578 F: +27 (031) 5637990	Megger Sweden AB Eldarvägen 4 Box 2970 SE-187 29 TÄBY SWEDEN T: +46 8 510 195 00 F: +46 8 510 195 95
<b>Switzerland</b>	<b>United Kingdom (Dover)</b>	
Megger Schweiz AG Ob. Haselweg 630 5727 Oberkulm Aargau T: +41 62 768 20 30 F: +41 62 768 20 33	Megger Limited Archcliffe Road Dover CT17 9EN  T: 01304 502101 F: 01304 207342	
<b>United States (Dallas)</b>	<b>United States (Valley Forge) MFG Plant + Product Management</b>	<b>United States (College Station)</b>
4545 W Davis St., Dallas, Texas 75211 USA  T: 1-800-723-2861 F: 1-214-331-7399	Valley Forge Corporate Center 2621 Van Buren Avenue Norristown, PA 19403 USA T: 610-676-8500 F: 610-676-8610 <b>Changing April 28<sup>th</sup>, 2022 to</b> 400 Opportunity Dr Phoenixville, PA 19460 <b><u>no change in phone / fax numbers</u></b>	4064 State Highway 6 South College Station, TX 77845 USA T: 979-690-7925 F: 979-690-0276

M

---



---

## Table of Contents

1	SAFETY .....	1
	Precautions .....	1
	Warning and Caution Notices.....	1
	Working with the Product .....	2
	Operating Personnel .....	2
	Repair and Maintenance .....	2
	General Cautions and Warnings .....	2
	Intended Application.....	2
	What to Do if Equipment Malfunctions .....	3
	Five Safety Rules .....	3
	Important Safety Advisory Note - When Working With Hv Surge Generator / Thumper ...	4
	Requirements for Safe High Voltage Work Environment .....	4
2	TECHNICAL DESCRIPTION.....	6
	System Description .....	6
	Functional Description.....	6
	Product Models .....	7
	Features .....	7
	Scope of Delivery .....	8
	Available Accessories.....	8
	Technical Data .....	9
	Control Elements, Indicators and Connectors.....	10
	Power Supply .....	11
	Battery Operation .....	11
	Introduction .....	11
	Battery Status and Automatic Shutoff .....	11
	Charging.....	12
	120/230V AC Line Operation.....	13
3	SETTING UP THE SYSTEM.....	14
	Connection Diagram.....	15
	Connection Sequence .....	15
4	OPERATING INSTRUCTIONS.....	16
	Power on the System.....	16
	Basics of Operation .....	16
	Operation with Rotary Knob.....	16
	High Voltage Control .....	17
	Safety Circuit .....	17
	Introduction .....	17
	Conditions of the Safety Circuit .....	18

---

User Modes .....	18
System Settings .....	19
5 HOW TO PERFORM A TEST .....	24
Detecting and Locating a Cable Fault in a Shielded Medium Voltage Power Cable .....	24
Locating a Faulty Cable Segment (Sectionalizing) .....	24
Introduction .....	24
How to Determine the Faulted Section .....	25
How to Verify a Faulted Cable Section .....	27
Locating a Cable Fault (shielded MV power cable) .....	28
How to Test the Dielectric Strength of the Cable .....	28
How to Pre-Locate the Fault .....	30
Arc Reflection Method (ARM) .....	30
Current Decoupling / Surge Pulse (ICE) <i>NOT AVAILABLE</i> in EZ-Thump Family .....	32
How to Pinpoint a High Resistance (Flash-over) Fault .....	32
Detecting a Sheath Fault in a shielded Medium Voltage Cable <u>or</u> a Ground Fault in an Unshielded, Low Voltage Cable (both must be directly buried) .....	34
How to Pinpoint a Sheath Fault in a Shielded Medium Voltage cable <u>or</u> a Ground Fault in an Unshielded Low Voltage Cable (both must be directly buried) .....	36
6 CUSTOMIZE TDR FEATURES (applicable to TDR and ARM Mode) .....	37
Introduction .....	37
Customized TDR Features .....	38
Completing the Operation .....	40
7 ADVANCED SYSTEM SETTINGS .....	41
How to Edit the Cable List .....	41
Introduction .....	41
XML Structure of a Cable List File .....	41
How to Edit the Cable List .....	42
How to Setup Customer-Specific TDR Features .....	43
How to Use EasyPROT Software to Plot DC HIPOT/Sheath Test Data .....	45
8 CARE and MAINTENANCE .....	46
Maintenance .....	46
Storage .....	46
APPENDIX 1 .....	48
Overview of TDR Features .....	49



---

---

## Receiving Instructions

1. Check the equipment received against the packing list to ensure that all materials are present. Notify Megger of any shortage. Email your local Service Representative or send to *VFCustomerSupport@Megger.com*.
2. Examine the equipment for damage received in transit. If damage is discovered, file a claim with the carrier at once and notify Megger, giving a detailed description of the damage.
3. Prior to operation, check for loosened hardware or damage incurred during transit. If these conditions are found, a safety hazard is likely, DO NOT attempt to operate equipment.

Please contact Megger as soon as possible.

Please check your delivery against:

- a) your order
- b) our advice note
- c) the item delivered, and
- d) the parts list

**any shortages must be reported immediately.**

## Consultation with Megger

The present system manual has been designed as an operating guide and for reference. It is meant to answer your questions and solve your problems in as fast and easy a way as possible. Please start with referring to this manual should any trouble occur.

In doing so, make use of the table of contents and read the relevant paragraph with great attention. Furthermore, check all terminals and connections of the instruments involved.

**Should any question remain unanswered, please contact:**

*VFCustomerSupport@Megger.com*

or

phone: +1.610.676.8500 (USA)

M

---

# 1

## SAFETY

### *Precautions*

This manual contains basic instructions on commissioning and operating the EZ-THUMP 3/4/12kV models. For this reason, it is important to ensure that the manual is always available to authorised and trained personnel. Any personnel who will be using the devices shall read and understand the manual thoroughly. The manufacturer will not be held liable for any injury or damage to personnel or property through failure to observe the safety precautions contained in this handbook.

Applicable local regulations must be observed.

### *Warning and Caution Notices*

Warning and caution notices are used throughout this manual where applicable. These notices appear in the format shown below and are defined as follows:

**F** **WARNING!**  
Warning, as used in this manual, is defined as a condition or practice which could result in personal injury or loss of life.

**G** **CAUTION**  
Caution, as used in this manual, is defined as a condition or practice which could result in damage to or destruction of the equipment or apparatus under test. The user must consult the User Guide when this symbol marked on the instrument.

**u** **PROTECTIVE EARTH TERMINAL**

<p><i>NOTE: The notes contain important information and useful tips for using the system. Failure to observe them can render the measuring results useless.</i></p>
---

## ***Working with the Product***

It is important to observe the general electrical regulations of the country in which the device will be installed and operated, as well as the current national accident prevention regulations and internal company rules (work, operating and safety regulations).

After working with the equipment, make sure to de-energise, protect against re-energising; discharge, earth and short-circuit the equipment and installations that have been worked on.

Use genuine accessories to ensure system safety and reliable operation. The use of other parts is not permitted and invalidates the warranty.

## ***Operating Personnel***

This system and its peripheral equipment may only be operated by trained or instructed personnel. Anyone else must be kept away.

The system may only be installed by a trained or authorized electrician. In Germany DIN VDE 0104 (EN 50191), DIN VDE 0105 (EN 50110) and the German accident prevention regulations (UVV) define an electrician as someone whose knowledge, experience and familiarity with the applicable regulations enables him to recognize potential hazards.

## ***Repair and Maintenance***

Repairs and service must only be done by Megger or Megger authorized service departments. Megger recommends having the equipment serviced and checked once per year at a Megger service location.

Megger also offers direct on-site support. Please contact our service office for more information

## ***General Cautions and Warnings***

### ***Intended Application***

Safe operation is only warranted if using the equipment for its intended purpose. Using the equipment for other purposes may result in bodily harm or death of the operator and damage the equipment itself and that of the involved test site.

The limits described under technical data may not be exceeded. Operating Megger products in environments, which feature high humidity in combination with condensation, may lead to flash-over, creepage, danger and damage. The instruments should only be operated under tempered conditions. Do not operate Megger products in direct contact with humidity, water or near aggressive chemicals nor explosive gases and fumes.

## What to Do if Equipment Malfunctions

The equipment shall only be used when working properly. If irregularities or malfunctions appear which cannot be solved consulting this manual, the equipment must immediately be put out of operation and marked as not functional. In this case inform the person in charge who should inform the Megger service to resolve the problem. The equipment shall only be operated after the malfunction is resolved.

### Five Safety Rules

The five safety rules must always be followed when working with HV (High Voltage):

1. De-energize
2. Protect against re-energizing
3. Confirm absence of voltage
4. Ground and short-circuit
5. Cover close by energized components



#### Using cardiac pacemaker

Physical processes during operation of high voltage may endanger persons wearing a cardiac pacemaker when near these high voltage facilities



#### Fire fighting in electrical installations

- According to regulations, **Carbon Dioxide (CO<sub>2</sub>) is required to be used** as extinguishing agent for fighting fire in electrical installations.
- **Carbon Dioxide** is electrically nonconductive and does not leave residues. It is safe to be used in energized facilities as long as the minimum distances are maintained. A **Carbon Dioxide** fire extinguisher must be always available within electrical installations.
- If, contrary to the regulations, any other extinguishing agent is used for firefighting, this may lead to damage at the electrical installation. Megger disclaims any liability for consequential damage. Furthermore, when using a powder extinguisher near high-voltage installations, there is a danger that the operator of the fire extinguisher will get an electrical shock from an ARC FLASH (voltage arc-over created by the powder dust cloud).
- It is essential to observe the safety instruction on the extinguishing agent.
- Applicable is DIN VDE 0132 in Germany

**WARNING****Dangers when working with HV****F**

Special attention and safety awareness are needed when operating HV equipment and especially non-stationary equipment. The regulations VDE 0104 about setting up and operation of electric test equipment, i.e., the corresponding EN 50191 as well as country-specific regulations and standards must be observed.

- Depending on the specific EZ-Thump system, it generates a dangerous voltage of up to 12kV during operation. This voltage is supplied via a HV cable to the test object.
- The system is not to be operated by untrained personnel and without supervision.
- Safety installations may not be by-passed nor deactivated.
- All metallic parts in proximity of the test equipment must be grounded to avoid the build-up of hazardous electric surface charges.

**F****WARNING**

Not paying attention or correcting unsafe conditions can lead to personal injury and potential death

**IMPORTANT SAFETY ADVISORY NOTE -  
WHEN WORKING WITH HV SURGE GENERATOR / THUMPER**

**REQUIREMENTS FOR SAFE WORK ENVIRONMENT WHEN PERFORMING MV or LV  
POWER CABLE FAULT LOCATING BY DISCHARGING A HIGH VOLTAGE CAPACITOR  
(Surge generator /Thumper)**

**Requirements for safe High Voltage work environment  
(schematic on next page)**

1. Safety Ground lead of unit is connected to system grounding point of power device, ①, e.g., transformer, switchgear etc., via proper clamp, no alligator clips.
2. High Voltage Return (= shield of test lead) ② is connected via clamp to concentric neutral (shield) of power cable to be tested *or* to the grounded second faulty core in case of belted MV cables *or* to the second faulty core of a LV cable.
3. High Voltage lead ③ is connected via clamp or other proper means to the conductor of the power cable to be tested, no alligator clips.

4. The Concentric Neutral (shield of the cable to be tested) of the MV power cable, or a second core of a LV cable to be tested must be bonded to the system grounding point of the power device (see also 1).
5. *The resistance of the system grounding point of the power device to earth ground must be 5 Ohms or less* when measured with an earth ground meter
6. If a **5  $\Omega$  or less condition cannot be attained**, the operator must follow the specific work procedures and instructions, applicable to a “hot”/“energized”/“live” work site; *in Europe EN 50110-1 is mandatory*, the reason being that in this situation the entire test circuit is “floating above earth ground” under HV test conditions and create a serious safety hazard for the operator.



# 2

## TECHNICAL DESCRIPTION

### *System Description*

#### Functional Description

The EZ-THUMP 3/4/12kV models are compact fault location system, typically to be used for fault locating of low voltage- and medium voltage power cables. They offer 2 power sources to be operated from. The 2 power sources are AC line voltage and an internal 24V battery system. When connected to the AC line, the portable EZ-THUMP 3/4/12KV MODELS will operate and charge its internal battery simultaneously.

The EZ-THUMP 3/4/12KV MODELS are ideally suited for use in both low voltage distribution- / street light systems *and* medium voltage URD systems (satellite concept) up to 25kV systems, depending on the model selected. They are qualified for all type of cable insulation materials, XLPE, EPR and also PILC due to their innovative Multishot ARM feature, which is unique in this equipment class . The main advantages of the EZ-THUMP 3/4/12KV MODELS are their solid HV performance, simple operation, automated fault locating process, capable of operation in rainy conditions, weight, ergonomics and being self-contained.

The EZ-THUMP 3/4/12KV MODELS provide the user with a battery operated *Tool Box Concept*, offering the same convenience as available in some innovative, larger, state of the art fault locating systems. This eliminates the need for the user to carry a variety of stand alone pieces of equipment to the job site. Beside the proven and superior pre-location method of inductive ARM technology, *combined with the Multishot feature*, the EZ-Thump provide the optional sectionalizing capability (trouble shooting in URD loop systems, North America) / splice identification in medium voltage cables. The integrated 500J single stage surge capacitor (2 stage 1.5/3kV capacitor in the 3kV unit) allows reliable fault pinpointing. The HV DC source for insulation break- down detection, the display of insulation resistance and LV cable Ground fault locating/ sheath testing / sheath fault locating locating complete the tool box (Ground fault- and Sheath fault locating require optional receiver ESG-NT).



## Product Models

There are 4 configurations available for the EZ-THUMP 3/4/12KV MODELS, *either* with 15 *or* 50ft (4.5 or 15m) HV/Ground leads *and either* as a portable version *or* mounted on an integrated, stainless steel hand truck with large air tires for easy use in open terrain.

This manual covers all models of the EZTV3-3/4/12 MODELS. If necessary, any differences are noted in the text.

## Features

The EZ-Thump Systems combine the following features and functions in a fully integrated, computer-controlled device:

- *Quick Steps, Expert Mode* and *TDR Manual Mode* allow to address 3 levels of user skill; *TDR Manual Mode* is *new* and only available in the new V3 models (equipped with the Multishot feature); *if set* to this mode, *all TDR features are always available on the user interface* and *must be selected / manually adjusted* by the user; *all automatic adjustments* known from Quick-Steps and Expert mode *are disabled in Manual Mode*. This mode caters to the small group of users who prefer to set the TDR up according to their own experience and expertise (*Sectionalizing* is *not available* when the *TDR is set to Manual Mode*).
- *Quick Steps* and *Expert Mode* provide Automatic fault Pre-location and Optional Sectionalizing (fault locating with regard to the 2 closest transformers *or* splice identification, this *optional software* is limited to use in *MV circuits*)
  - Quick Steps and Expert Mode provide Automatic cable end and fault detection and localization
  - DC test up to 3 / 4 or 12kV with automatic breakdown detection and insulation resistance measurement
  - *or MV Sheath Fault Test* with automatic Pinpointing of high resistance faults in surge mode (0-3, 0-4, 0-12kV)
  - *LV Ground Fault Test* breakdown detection (3,4 or 5kV max. depending on model)

- LV *Ground Fault*- or MV *Sheath Fault pinpointing* (requires optional receiver ESG-NT) (3,4 or 5kV max. depending on model)
- Integrated safety circuit for user's safety (**F-OHM for verification of correct connections** of *Safety Ground* and *HV Return*)
- Optional external remotely operated safety device to *shut off HV* and *ground EZTV3-3/4/12 MODELS* (remote Emergency Off function)
- Operation from internal battery / inverter or from an external AC or external DC source (e.g. external battery)
- Sturdy and dust /weatherproof enclosure for outdoor use, IP53

### Scope of Delivery

The scope of delivery of the EZ-THUMP 3/4/12KV MODELS comprises of the following components:

- HV output cable hard wired (15ft/4.2m or *optional* 50ft/15m)
- Safety Grounding cable hard wired
- AC Power cord
- Owner's manual

### Available Accessories

The following accessories\* can be ordered from Megger, if required:

Accessories	Description	Item number
Elbow adaptor with 14 mm female MC connector, fits T1 terminations  <i>(NAFTA market)</i>	Used to connect HV output cable to transformer or switchgear bushing	865000100100000 (15 kV)
		865000200100000 (25 kV)
		865000300100000 (35 kV)
External safety device	Safety device with signal lamps, key switch, and EMERGENCY OFF switch	893024147 and 890024896

\*See also separate **Data Sheet** for optional accessories and cable reels *CFL\_ACCESS\_DS\_US\_V05*

## Technical Data

Parameter	Value
DC Test voltage	0 to 3/4/or 12 kV depending on model
Surge voltage	0 to 3/ 0-4/ 0-12 kV depending on model
Source current	up to 94mA 3kV unit, up to 36mA 4kV unit, up to 12mA 12kV unit,
Insulation measurement	2 kΩ ... 10 MΩ
Surge energy	500J @ max. voltage in each of both surge levels 1.5kV / 3kV for 3kV unit 500J @ max. voltage of 4 and 12kV units
AC Power Input	100-264V, 50-60 Hz 2A 230V internal fuses (line and neutral) IEC320-C14 receptacle
Internal Battery	NiMH battery, 24V/5AH
Operating time battery	45 min (pinpointing) at full energy
Power consumption	144W
Display	7", 1280 x 800 pixel HighBrite TFT direct sunlight readable
Memory	>100 traces
Interfaces	USB port
TDR Range 3/4/12KV MODELS	up to 170,000ft / 52km
Measuring resolution	0.8 m (2.6 ft) at 78 m/μs (255 ft/μs)
Max. sampling rate TDR	100 MHz
Update rate	5 samples / second
Dynamic range	64 db
Output impedance	64 Ω
Operating temperature	-20 °C to +50 °C / -4°F to +122°F
Storage temperature	-25 °C to +70 °C / -13°F to +122°F
Intended Environment	Indoor and Outdoor
Relative Humidity	0-95% (non-condensing)
Operating Altitude	0 to 2000 meters / 6500 ft
Dimensions (W x H x D)	16x24x14 / 405/610/355mm
Weight	75lbs / 35kg (portable version)
Protection class (in accordance with IEC 61140)	I
Protection rating (in accordance with IEC 60529)	IP53 (open lid)

### Control Elements, Indicators and Connectors

The EZ-THUMP 3/4/12KV MODELS has the following control elements, indicators, and connectors:

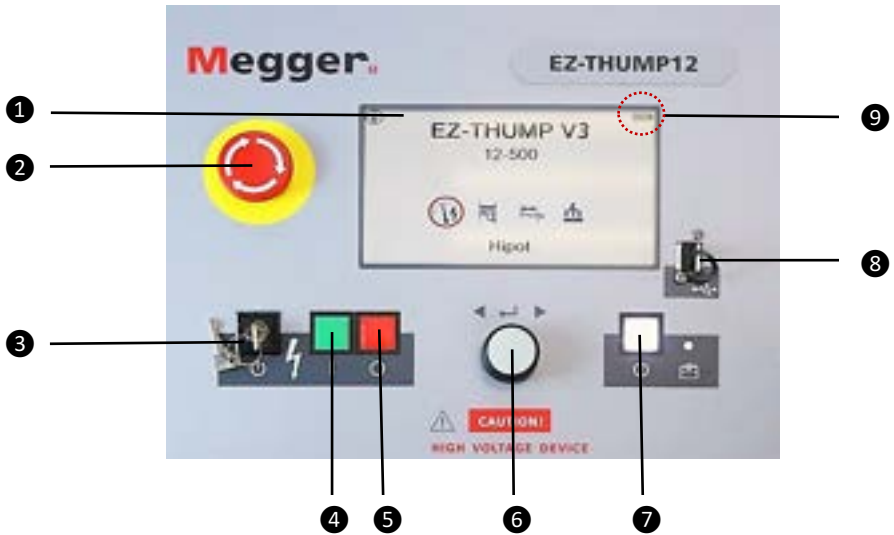

Element	DESCRIPTION	Element	DESCRIPTION
1	Display 7 inch	8	USB port
2	Emergency stop button	9	Battery Indicator Bar (green, orange, red) <i>see next page</i>
3	HV key switch	10	AC power connector , <i>see next page</i>
4	"HV ON" button	11	Jack for connecting external safety device <i>see next page &amp; page 10, Avail. Accessories</i>
5	"HV OFF" button	12	Charger Status Indicator LED <i>see next page</i>
6	Rotary control knob		
7	"ON / OFF" button		

# Power Supply

## Battery Operation

### Introduction

All EZTV3-3/4/12 MODELS, besides operating of line voltage, are equipped with an internal battery, and if fully charged, the units can deliver up to 400 HV discharges (thumps) at full voltage (in each range). This approximately equals 1 hour of thumping (pin-pointing) at full energy at the minimum required charging rate for the maximum voltage (1.5/3, 4 or 12kV).

### Charging Status, Battery Status and Automatic Shutoff

The *charger status* indicator LED ⑫ is located on the front panel, just below the AC receptacle, see photo below. The color of the LED changes depending on the status, which is explained on the legend below the LED. The *battery status* indicator bar ⑨ shows 4 green bars for a *fully charged battery*. After approx. 25 minutes of thumping at full energy 3 green bars will be visible. After an additional 10 minutes, 2 yellow bars will appear. After another additional 10 minutes the single red bar will be visible. The times given are approximate values. The best indication of the true capacity of the battery is when looking at the voltage recovery during the thump operation. The highest energy draw is experienced at the end of the full charging cycle of the capacitor when the largest charging energy is drawn. Initially, it is expected that the battery might lose the 4<sup>th</sup> bar at the end of the capacitor charging cycle, but when finished, it should always recover to the 4-bar state. The 25 minutes mentioned above means that after 25 minutes the voltage will not recover any more to the 4-bar status but remains at 3 bars and show the same behavior as described above for the 4 bars, and so on.

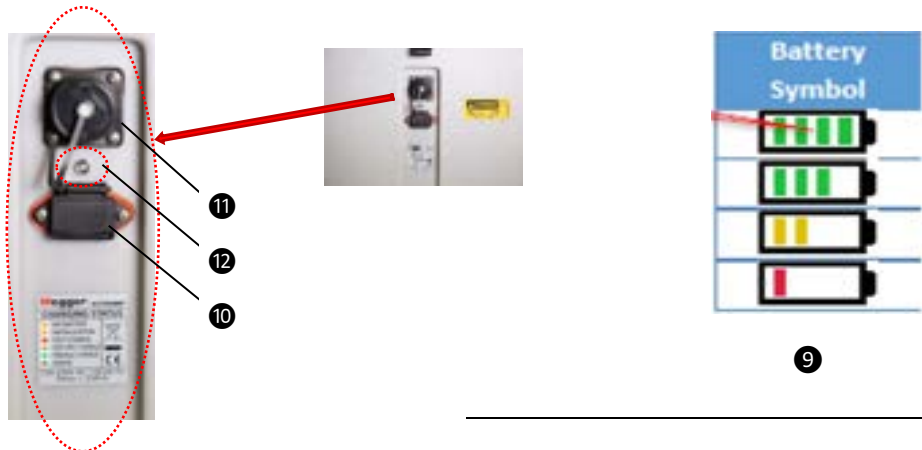

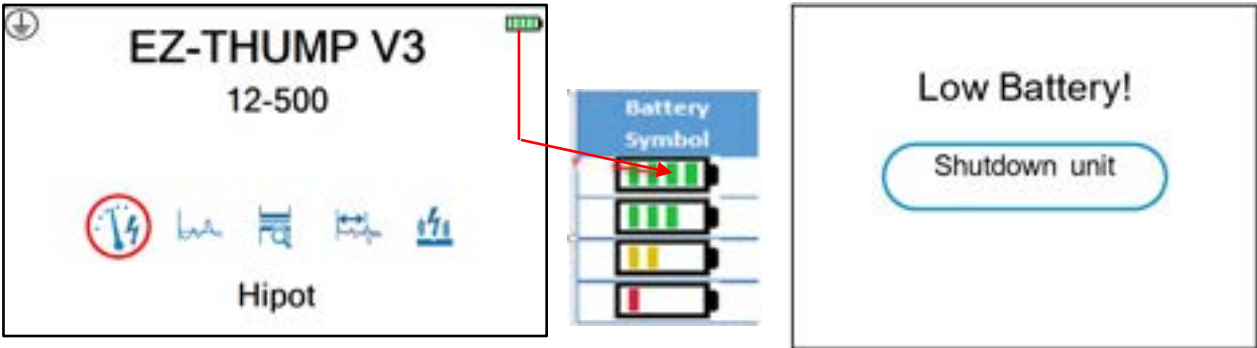

*NOTE: To protect the battery from a deep discharge, the unit turns off automatically completely or provides an error message if the battery is discharged too low for safe operation, see above.*

*NOTE: To find out whether the battery charge is sufficient for further use of the unit in the field, turn the unit on in battery mode check, the battery symbol should show 4 green bars.*

**Charging**

The battery is automatically being charged as soon as the EZ-THUMP 3/4/12KV MODELS has been connected to 120/230 AC line power. Initial charging time is about 10 to 12hrs. The progress of the charging process is indicated by the battery charging status LED **9**. During charging, the LED lights yellow. It turns to green, when the battery is full and charging is finished, but even when it turns green, leave unit plugged in to the AC line to maintain “trickle charging”

*NOTE: Always charge the battery immediately after use. Even NiMH batteries can be cycled to optimize their life, it is the best compromise to keep the unit (battery) plugged in whenever the unit is not in use.*  
**This can be accomplished by keeping the unit connected to a working AC outlet at all times except when wanting to operate it from its internal battery or an alternate AC supply.**  
**The typical life expectancy for NiMH batteries is between 2 and 3 years, after which it must be replaced. The battery in the EZ-THUMP models V2 and V3 is customer replaceable, please contact Customer Service.**

## 120/230V AC Line Operation

As soon as the AC power cord is connected between the receptacle  of the EZ-THUMP and the AC, *the system is operating on AC power, and with the internal battery installed, it is being charged at the same time.*

If using a power cord other than the one provided, ensure it is rated for at least 250VAC and is 18 AWG or larger. Do not use inadequately rated power cords.

# 3

## SETTING UP THE SYSTEM

### F

#### WARNING - Safety instructions for setting up

- The guidelines to maintain occupational safety when operating a non-stationary test system often differ between network operators and it is not uncommon to use National regulations (i.e., the German BGI 5191)

Operator must inform him/herself about the guidelines applicable in the area of operation beforehand and comply with specific work rules for non-stationary test systems.

- Always follow the safety instructions (*see Section 1 SAFETY*) - the **five safety rules** (*see page 3*) - before connecting to the cable to be tested.
- Before connecting the system to the cable to be tested, be sure that the cable has been tested for voltage, discharged / isolated and ground tested in compliance with all OSHA / National applicable & company safety procedures.
- Select a setup location which is sufficient for the weight and size of the system and ensure that it stands securely. Always locate the system off to the side of the cable path, never on top of the cable path of the faulted cable.
- When setting up the testing system, ensure that it does not impair the function of any other systems or components. If other systems and components must be modified to set up and operate the test system, be sure to reverse these actions when the work is finished. Always take the special requirements of these systems and components into account and only carry out work on them after consulting and obtaining approval from whoever is in charge.
- Install protective equipment (such as railings, chains, or bars) around the test site to block access to the danger zone and prevent the risk of touching live parts.
- Always operate the EZ-THUMP 3/4/12kV models in a vertical position. Grounding and HV contacts both require a vertical orientation to ensure proper functioning as well as a "Fail Safe Position" in case of an AC or DC power failure or if the unit needs to be shut off.
- After receiving clearance, make sure that NO dangerous voltages can reach unprotected places or technical equipment.
- As a matter of principle, all de-energized cables that are part of the test circuit shall be connected and shorted to ground.



## Connection Diagram

The following figure shows the simplified connection diagram  
*please review also important safety advisory on pages 4 and 5*

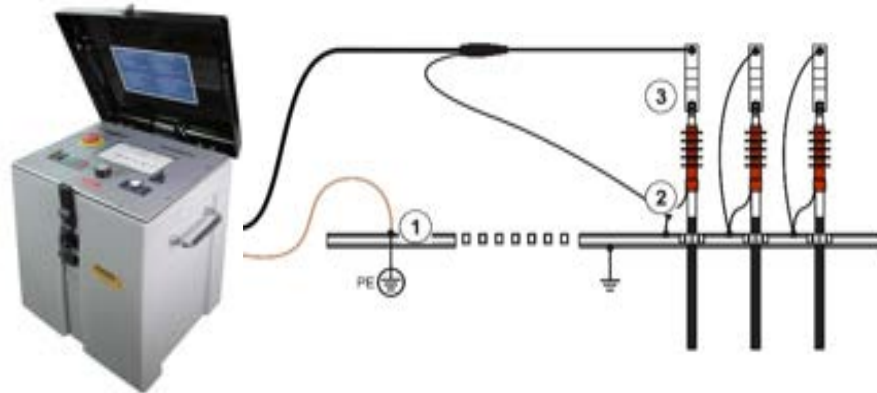

## Connection Sequence

Connect the unit in the following order:

Step	Description
①	<b>Connect the safety ground lead</b> to a reliable ground (e.g., station-ground, transformer ground rod, <b>do not drive a <u>separate</u></b> ground rod!).
②	<b>Connect the HV return lead</b> to the cable shield / the concentric neutral of the specific cable to be tested. The resistance between the HV return (operational ground) and the safety ground should be less than 5 $\Omega$ (check with ohmmeter, if questionable), if not the F-OHM safety feature will be activated automatically, disabling the HV ON function or activating automatically the HV OFF function <div style="border: 1px solid black; padding: 5px; margin-top: 10px;"> <p><i>NOTE: It is important to connect the HV return to the shield / concentric of the cable to be tested as close as possible to the breakaway point, the TDR trace readings will be much better!</i></p> </div>
③	<b>Connect the HV lead</b> to the phase conductor to be tested (optional elbow adapter or vice-grip. (See 'Available Accessories' in Section 2).
④	<b>Connect the supplied power cord</b> to the connector  on the front of the unit and connect the other end to a power outlet. <div style="border: 1px solid black; padding: 5px; margin-top: 10px;"> <p><i>NOTE: If no power connection can be established, the unit can be operated from the internal battery, provided it is properly charged.</i></p> </div>
⑤	Only after all necessary connections have been made, <b>the ground connection to the cable under test shall be lifted.</b>

# 4

## OPERATING INSTRUCTIONS

### *Power on the System*

Once the "ON / OFF" button **7** is pressed, the system starts up. After start-up, the system is in the 'Ready for the state of operation and the *main screen* is displayed:



The main screen image should show at least the 3 most commonly used fault locating tools

- HIPOT
- ARM PRELOCATION
- PINPOINTING (*other elements or modes of operation can be set up by user; an additional icon for each selected mode will show on the main screen.*)

In this state, the high voltage source is still switched off and the high voltage output is grounded via a discharge resistor.

### *Basics of Operation*

#### **Operation with Rotary Knob**

Navigation within the menus is done using the rotary knob **6** as follows:

- |          |   |                               |
|----------|---|-------------------------------|
| Turning  | ➡ | Selecting                     |
| Clicking | ➡ | Confirming ("ENTER" function) |

The currently selected menu item is identified by a red circle.

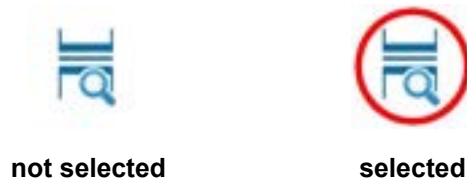

With the aid of the rotary knob, the individual menus can be accessed, and values can be entered. If a selected menu item requires a value to be adjusted, the following dialog is displayed:



The value for the parameter can then be adapted by turning the rotary knob and clicking it again to confirm.

## High Voltage Control

Before starting any HV test, the user is prompted to enable high voltage. To do so, the green illuminated “HV ON” button **4** (green) must be pushed. This disconnects the discharge resistor and enables the generation of high voltage. The red illuminated “HV OFF” button **5** signals that the HV output is now energized (see also active HV symbol in upper left-hand corner of LCD ) and the green button goes dark.

The activation of high voltage requires that all conditions of the safety circuits are met, see also page 17 in Section *Safety Circuit*.

The high voltage can be switched off at any time during the course of the test by pushing the “HV OFF” button **5**. The test is then immediately aborted, and the high voltage power supply is turned off and the entire test circuit including the EZ-THUMP 3/4/12KV MODELS is discharged and grounded, which is indicated by grounding symbol  in the upper left-hand corner of the LCD screen.

## Safety Circuit

### Introduction

Once high voltage is turned on (Red HV OFF button is illuminated), the system's safety circuit continuously checks all safety-relevant parameters

and switching operations of the system. Should the safety circuit detect a violation of the monitored thresholds / conditions while in high voltage mode, the system automatically switches the high voltage power supply off and discharges and grounds the HV output. A message will be displayed on the LCD display which *must be acknowledged* before any operation can be re-activated again.

## Conditions of the Safety Circuit

The following safety conditions must be met to allow to perform tests under high voltage:

- The HV key switch ③ *must be* in the ① position (*some systems might not have this feature because they were ordered without it*)
- The emergency off button ② *must be* unlocked (up).
- The F-Ohm safety circuit *must* have a loop resistance *below 6.5 Ω* (if resistance is higher, warning on LCD will be provided and system *will lock out any HV application*).

*NOTE: If the HV application is disabled because of one or more of these conditions are not being met, they must be eliminated, and the message must be acknowledged before HV ON can be enabled again.*

## User Modes

The E-TRAY system platform offers two (3) operational modes respectively three (3) if the unit is equipped with the Multishot feature

- **QUICK STEPS Mode (not password protected):**  
This mode is tailored for the “everyday jobs” where the basic settings may need no or just minor adjustments. This mode is typically configured with a limited range of adjustment features and no access to the system settings. It serves also very well the „casual“ user of the unit
- **EXPERT MODE (password protected):**  
This mode is recommended for experienced users. It offers the full range of adjustment features (if selected and set-up by the user) and access to all customer accessible system settings, incl. the default settings.
- **MANUAL Mode (password protected,  
only available in units with *Multishot Feature*):**  
the Manual Mode is activated after accessing the DEFAULT *settings and selecting MANUAL MODE of OPERATION.*

This mode is only recommended to the group of users with *extensive experience and expertise in the set-up* and operation of the TDR. When selecting this mode, *all automatic functions* like **auto-ranging** and **auto-gaining**, and also the **automatic detection** of the **cable end** and the **distance to fault** *have been turned off and must be adjusted manually.*

For detailed information on how to switch modes, please refer to the next paragraph below.

### System Settings (*only accessible in Expert Mode, password protected*)

In order to change the system- and or default settings, **EXPERT settings**  must be accessed from the main screen.

These settings are only available, if the system is operated in **Expert Mode**. If not in **Expert Mode**, the rotary knob  must be pushed down and held down shortly on any of the **main screen** icons until the system displays the prompt for the password, which is required to activate the **Expert Mode**. The default password is “0000” (can be changed – see below but *is not recommended*).

After activation of the **EXPERT MODE**, the user is automatically forwarded to the system settings:

Menu item	Description	
<b>Leave EXPERT MODE</b>	By leaving the expert settings through this menu item the new settings are saved and the system is switched to <b>QUICK STEPS mode</b> . The  is no longer displayed in the main menu which prevents unauthorized persons from changing the system and default settings.	
<b>Date / Time</b>	Date and time settings	
<b>Language</b>	Language settings	
<b><u>Default Settings</u></b>		
<b>&gt;&gt; Measurement unit</b>	<b>Length</b>	Unit of the x-axis ( <b>Meter, Feet or Time</b> ). If set to <b>Time</b> , the actual runtime of the pulse is displayed and no conversion to length of cable is performed.
	<b>Rate</b>	<u><i>Only available, if Length is set to Meter or Feet</i></u> Rate refers to how the propagation velocity of the TDR pulse is specified. This can be done <i>either</i> relative to the speed of light ( <b>% of NVP</b> ) or in absolute units in $\mu\text{s}$ ( <b><math>\mu\text{sec} = \text{microseconds} = 10^{-6} \text{ sec}</math></b> ).
<b>&gt;&gt; V/2 or NVP</b>	<u><i>Only available if Length is set to Meter or Feet</i></u> Propagation velocity of the cable under test can be expressed as percentage of speed of light (NVP), e.g., 0.53 corresponds to 53% of speed of light V/2 (half of the actual velocity of propagation) in m/ $\mu\text{s}$ .	

Menu item	Description
<p>&gt;&gt; <b>TDR - Mode Selection</b></p>	<p><b>AUTOMATIC TDR Operation</b> means that the software utilizes algorithms to determine the end of the cable, the distance to fault, automatically sets the range, the gain, and the pulse width, it also allows user to select which TDR features to make available in both the QUICK-STEPS and EXPERT Modes</p> <p><b>MANUAL TDR OPERATION</b> means that all automatic functions listed above must be done manually by the user; it also means that <b>all</b> TDR features are available at <b>all times</b> on the screen (<i>only recommended for a knowledgeable TDR expert</i>)</p>
<p>&gt;&gt; <b>Automatic HV release</b></p>	<p>The way a HV test is started, <b>automatic</b> or <b>manual</b>.</p> <p><b>Automatic</b> means that after initializing HV by pushing the HV ON button, HV will be building up in the test mode or will charge the capacitor <b>and</b> release as soon as pre-set voltage has been reached (<i>typically preferred in North America</i>).</p> <p><b>Manual</b> means that in both situations the HV, after having been authorized, has to be manually “initiated”, and once more after the preset level has been reached <b>and</b> the charge is to be released (<i>typically preferred in Europe</i>).</p>
<p><b>Voltage selection <u>manual</u> or <u>automatic</u></b></p>	<p>When set to <b>Manual</b> the unit will always default to 0.1kV as a <u>starting level in all HV modes</u>. The operator must then adjust the HV level in any of the operating modes and operation menus involving HV to the desired level (Quick-Steps, Expert mode, and Manual TDR mode).</p> <div style="border: 1px solid black; padding: 10px; margin-top: 10px;"> <p><i>NOTE: It is recommended that all EZ-THUMP 3/4/12KV MODELS are set to Manual Voltage Selection in order to avoid an automatic HV build-up to the max. voltage capability of the specific model, especially if units are used on LV and MV cables interchangeably. This will eliminate the danger for an user, who might not be totally familiar with the feature structure to be unexpectedly confronted with the situation of a HV being applied beyond the voltage withstand capability of the test object.</i></p> </div>
<p><b>Sheath Test Limit</b></p>	<p>If the <u>Sheath Test Mode</u> is enabled, the test voltage that can be adjusted between 2 and a maximum voltage of 5kV</p>
<p><b>Continuous Testing</b></p>	<ol style="list-style-type: none"> <li>1. <b>When disabled</b>, only <u>DC HIPOT / breakdown</u> tests can be performed.</li> <li>2. <b>When enabled</b>, <u>DC HIPOT /Proof</u> tests can be performed for up to 30 minutes and the data can be exported via USB stick and loaded on the EasyPROT software.</li> <li>3. <b>Must be enabled</b> to perform Sheath Testing / Sheath Pinpointing.</li> </ol>

Menu item	Description								
<p>&gt;&gt; <b>Set-up Start Marker</b></p>	<p>Procedure to adjust the start marker "zero" position to the end of the actual length of the HV output cable, for portable EZ-THUMP 3/4/12KV MODELS at the end of the typical 50ft (15m) HV output cable; for vehicle mounted units typically optional cable reels are installed, and the Start Marker is set to the end of the output cable of the HV reel, could be 50ft (15m), 85ft (25m) or 130ft (40m). The procedure is fully automatic and the operator is prompted to perform the required steps:</p> <ol style="list-style-type: none"> <li>1. a measurement is taken with the ends of the HV test lead open</li> <li>2. the gain setting is adjusted <i>if needed</i> and confirmed and a copy of the trace is saved automatically (adjust gain of furthest peak on left till peak can be seen clearly, <i>no clipped top</i>)</li> <li>3. a second trace is automatically saved when the 2 ends of the HV test lead are shorted to each other, should show a significant downward blip. The marker is automatically placed on the position where both traces start to split.</li> </ol> <p><i>If required</i>, the marker can be manually adjusted. This setting of the start marker will be stored as the default after operator acknowledges the prompt and <b><u>should only be changed if the length of the HV connection cable is changed.</u></b></p>								
<p><b>Cable List</b></p>	<p>By means of the cable list the appropriate propagation velocity can be quickly adjusted / selected by identifying the type of cable to be tested.</p> <p>Cable list can be exported and imported which allows for example to edit an exported list (XML file) according to the preferences of the customer (see page 41) and then share it among all units of a customer.</p> <p>This submenu offers the following options:</p> <table border="1" data-bbox="505 1129 1482 1507"> <tbody> <tr> <td data-bbox="505 1129 678 1241"><b>Set default</b></td> <td data-bbox="678 1129 1482 1241">Allows selection of <i>one cable</i> list amongst all available cable lists <i>as default</i>. Only the cable types of the default cable list can be accessed during measurement.</td> </tr> <tr> <td data-bbox="505 1241 678 1352"><b>Import from USB</b></td> <td data-bbox="678 1241 1482 1352">Imports a cable list from an inserted USB drive. The cable list must be located in the <i>CableLists</i> folder and be formatted correctly (see Chapter 7)</td> </tr> <tr> <td data-bbox="505 1352 678 1423"><b>Export to USB</b></td> <td data-bbox="678 1352 1482 1423">Exports the selected cable list to the <i>CableLists</i> folder on the USB drive.</td> </tr> <tr> <td data-bbox="505 1423 678 1507"><b>Remove cable list</b></td> <td data-bbox="678 1423 1482 1507">Removes the selected cable list from internal memory.</td> </tr> </tbody> </table>	<b>Set default</b>	Allows selection of <i>one cable</i> list amongst all available cable lists <i>as default</i> . Only the cable types of the default cable list can be accessed during measurement.	<b>Import from USB</b>	Imports a cable list from an inserted USB drive. The cable list must be located in the <i>CableLists</i> folder and be formatted correctly (see Chapter 7)	<b>Export to USB</b>	Exports the selected cable list to the <i>CableLists</i> folder on the USB drive.	<b>Remove cable list</b>	Removes the selected cable list from internal memory.
<b>Set default</b>	Allows selection of <i>one cable</i> list amongst all available cable lists <i>as default</i> . Only the cable types of the default cable list can be accessed during measurement.								
<b>Import from USB</b>	Imports a cable list from an inserted USB drive. The cable list must be located in the <i>CableLists</i> folder and be formatted correctly (see Chapter 7)								
<b>Export to USB</b>	Exports the selected cable list to the <i>CableLists</i> folder on the USB drive.								
<b>Remove cable list</b>	Removes the selected cable list from internal memory.								
<p><b>User mode</b></p>	<p>Menu item to select the <i>User Mode</i> which is the <i>default after start-up</i>.</p> <p>If set to <b>Last</b>, the unit starts up in last active mode, <b>recommended is to set always to QUICK STEPS</b> (<i>no password required, access to any defaults or settings is disabled</i>)</p>								
<p><b>Backlight settings</b></p>	<p>Backlight timeout and contrast settings.</p>								
<p><b>Time Out Settings</b></p>	<p>Minutes of inactivity after which system is automatically shut down (conserve battery).</p>								

Menu item	Description
<b>Stored Traces</b>	<p>Menu item to export or delete all traces which have been stored in the internal memory.</p> <p>Exporting traces requires a USB flash drive plugged into the USB port . The traces are written into a <i>EtrayTraces</i> folder which is automatically created.</p> <p>The data can be viewed with any standard web browser by opening the <i>index.html</i> file which is also located in the <i>EtrayTaces</i> folder.</p> <div style="border: 1px solid black; padding: 5px; margin-top: 10px;"> <p><i>NOTE: when in the LOCATE Mode (ARC Reflection), the unit will save and store automatically both the blue (LV) and the red trace (HV) as long as both traces are shown together on the screen (complete measurement); if only the blue trace (LV) is shown, it will not automatically be saved ; it can be saved via the feature „SAVE CURRENT TRACE“, please see chapter 6, CUSTOMIZE TDR FEATURES</i></p> </div>
<b>System information</b>	Displays the detailed hardware and software configuration of the unit.
<b>Change password</b>	To change the password (not recommended), <b>EXPERT MODE</b> must be enabled.
<b>System Configuration (user configurable settings)</b>	<b>Aside from</b> to the <u>factory preset unit configuration</u> the user has the choice to select or de-select amongst 5 additional fault locating features. <b>When selected</b> , a specific icon for each of the features will appear on the main screen (see page 19, <i>Power on the System</i> )
<b>TDR Time Domaine Reflectometer</b>	Selecting the <b>YES</b> key, allows the user to set up an operational mode to use the TDR by itself, <i>without any integration into one of the HV fault Prelocation modes</i> like ARM or ICE. In this mode the TDR is performing low voltage (<60V) time reflectometry and evaluating the impedance along a MV (shielded) cable or between 2 conductors of a multicore cable. This setting is also very helpful to fault locate multicore LV cables
<b>Sheath-fault locating</b>	By activating this mode of operation, the user can conduct <i>Sheath Fault Locating of MV</i> (shielded) cables or <i>Ground Fault testing on LV</i> (unshielded) cables. In this mode the unit will send out a pulsed DC signal with an adjustable voltage of max. 5 kV. Please see page 41 for application notes & additionally required equipment.
<b>Burning</b>	Burning is typically applied to a known failed cable in order to reduce its fault resistance. This is sometimes required to be able to surge / thump the cable, <b>typically used with PILC cables, but not XLPE/EPR cables.</b>
<b>Sheath Test</b>	By activating this mode of operation, the user can conduct Sheath Testing of MV (shielded) cables according to the applicable standards or Hipot testing on LV cables with the test voltage limited to 5 kV max.
	<div style="border: 1px solid black; padding: 5px; margin-top: 10px;"> <p><i>NOTE: when selecting this feature, the feature Continuous Testing (see page 25) must be also activated.</i></p> </div>
<b>ICE / Surge Pulse</b>	<b>Is not available</b> on any models of the EZ-Thump family



---

Menu item	Description
<b>Customize TDR features</b>	Menu to configure the features which are available during measurement, for either QUICK-STEPS mode or EXPERT mode. See page 43; <b>not available in Manual Operation, please see page 23</b>
<b>Return</b>	By leaving the <b>EXPERT MODE</b> through this menu item, the new settings are saved.

# 5

## HOW TO PERFORM A TEST

### ***Detecting and Locating a Cable Fault in a Shielded Medium Voltage Power Cable***

#### **Locating a Faulty Cable Segment (Sectionalizing)**

##### **Introduction**

The sectionalizing technique is used to trouble shoot single phase MV distribution loop circuits in order to identify the faulted section, so it can be quickly switched out, the rest of the circuit can be re-energized and the power outage kept to a minimum. The advantage is that the faulted section can be identified working from one set-up point without having to go from transformer to transformer to either remove the fuses or to stand the elbows off at each transformer.

For this purpose, a LV reflection image is taken and scanned for impedance changes that are related to the cable end and the transformers. The latter ones indicate the location of the transformers. A second reflection image of a TDR pulse is taken while an electrical arc is ignited by a sudden discharge of the charged capacitor at the fault location.







With both traces lying on top of each other, the fault location (position where the two traces diverge from each other) is identified and the transformers reflections provide the landmarks to identify the faulted cable segment. It will be switched out by pulling the elbows to the left and right side of the fault. Service to all customers is provided by closing the normally open point within the distribution loop.







The software package to perform the fault locating method called “Sectionalizing”, if ordered by the customer, will automatically perform the following procedure:

- Determine the distance to the end of the cable or an open point in the circuit (blue trace, live trace)

- Determine the distance to the fault using the ARM method (red trace, frozen)
- Determine the number of transformers up to the fault & one beyond it
- Based on relative position of fault to the 2 closest transformers the faulted cable segment can be identified and easily isolated









**How to Determine the Faulted Section**

Step	Description
1	<p>Select the  menu item from the main menu or from the  submenu (depends on the system configuration).</p> <p><b>Result:</b> A LV pulse is fed into the cable. The reflection image is processed by the transformer identification software. After a few seconds, the reference trace which shows the distance to the cable end.</p> <div style="display: flex; align-items: center;">  <div style="border: 1px solid black; padding: 5px; margin-left: 20px;"> <p>This reference trace is also called "live" trace because it is permanently refreshed and displayed</p> </div> </div>
2	Select  to start the fault location.
3	Adjust the surge voltage and select  to confirm the value (not required in automatic mode).
4	Press the green illuminated "HV ON" button  .
5	<p>Select  to <i>charge</i> the surge capacitor (only if <b>measurement start</b> option is set to <b>manual</b>. See page 19).</p> <p><b>Result:</b> The capacitor is charged up to the selected voltage.</p>

Step	Description
6	<p>Select  to <i>discharge</i> capacitor (only if <b>measurement start</b> option is set to <b>manual</b> (not required in automatic mode). See page 19.</p> <p><b>Result:</b> A capacitor discharge (shot) is initiated.</p> <p>If a voltage breakdown takes place, the red fault trace is shown in the display. The red fault marker is automatically set to the position where both traces diverge from each other. The fault is referenced to the 2 closest transformers, which identify the cable section containing the fault.</p>  <p><i>NOTE:</i> If no trigger is received and, thus, no fault trace is shown, you may try to repeat the procedure with a higher surge voltage (if possible) by selecting the repeat  icon.</p>
7	<p>Select  to Identify Transformers</p> <p>The special software identifies the transformers in front of the fault and one transformer past the fault. This will clearly identify the bad section of cable. By pulling the 2 elbows on either side of the fault the bad segment is isolated. By closing in the NO (normal open point) all customers will have power.</p>  <p>If necessary, adjust the display settings, TDR settings and marker position through the  menu in order to uniquely identify the affected section.</p>

**How to Verify a faulted Cable Section**

The HIPOT test within the context of Sectionalizing is done to confirm, that the section of cable identified as faulted during the preceding Sectionalizing procedure can be verified to be actually faulted. Proceed as follows to perform a HIPOT test *after the identified cable section has been isolated at the 2 closest transformers* (DC HIPOT test cannot performed with the transformers still connected to the faulted cable section):

Step	Description								
1	Select the  menu item from the main menu or from the  submenu (depends on the system configuration).								
2	Adjust the test voltage and select  to confirm the value.								
3	Press the green illuminated “HV ON” button  .								
4	Select  to start the test (only if AUTOMATIC VOLTAGE RELEASE option is set to manual. See “System Settings” on page 24).								
	<p><b>Result:</b> The selected voltage is applied to the cable.</p> <p>During the rise of the voltage the maximum charging current of the HVPS will be displayed till the cable has been fully charged, at which time the current will drop down to the actual leakage current level. The insulation resistance is displayed. This scenario is observed if the cable has <i>no insulation breakdown</i>, otherwise the high voltage will be shut off when the flashover/breakdown occurs.</p> <p>Depending on whether or not a breakdown takes place during the test, one of the following results is presented in the display:</p>								
	<table border="1"> <tr> <td><b>Breakdown at...kV</b></td> <td>A voltage breakdown took place at the indicated test voltage.</td> </tr> <tr> <td><b>No Flash-over</b></td> <td>The cable has withstood the applied DC test voltage. If possible, repeat () the test with higher voltage (do not exceed the maximum permissible voltage).</td> </tr> <tr> <td><b>Cable not chargeable</b></td> <td>The cable could not be charged by the test voltage. This is typically due to a short (fault) in the cable, creating maximum current output.</td> </tr> <tr> <td><b>Low resistance at ...kV</b></td> <td>The HV source cannot charge the cable beyond the indicated voltage value due to the substantial leakage current level.</td> </tr> </table>	<b>Breakdown at...kV</b>	A voltage breakdown took place at the indicated test voltage.	<b>No Flash-over</b>	The cable has withstood the applied DC test voltage. If possible, repeat (  ) the test with higher voltage (do not exceed the maximum permissible voltage).	<b>Cable not chargeable</b>	The cable could not be charged by the test voltage. This is typically due to a short (fault) in the cable, creating maximum current output.	<b>Low resistance at ...kV</b>	The HV source cannot charge the cable beyond the indicated voltage value due to the substantial leakage current level.
<b>Breakdown at...kV</b>	A voltage breakdown took place at the indicated test voltage.								
<b>No Flash-over</b>	The cable has withstood the applied DC test voltage. If possible, repeat (  ) the test with higher voltage (do not exceed the maximum permissible voltage).								
<b>Cable not chargeable</b>	The cable could not be charged by the test voltage. This is typically due to a short (fault) in the cable, creating maximum current output.								
<b>Low resistance at ...kV</b>	The HV source cannot charge the cable beyond the indicated voltage value due to the substantial leakage current level.								
5	Select  to return to the main menu.								





## Locating a Cable Fault (shielded MV power cable)



### How to Test the Dielectric Strength of the Cable

A HIPOT/breakdown test is used to test the dielectric strength of a cable under DC HV conditions, and in case the cable fails, provides the breakdown voltage. For this purpose, the individual EZ-Thump models will apply a test voltage of up to the specific max. kV rating of the model to the cable under test (automatically 12kV if a 12kV unit is set to AUTOMATIC VOLTAGE control ; if set to MANUAL VOLTAGE CONTROL, the user must first adjust the voltage to the level he selects)

*NOTE: If selecting the DC HV test voltage, its minimum should equal to the phase to voltage  $V_o$  AC (rms) multiplied by 1.41,  $V_o$  can be calculated by dividing the system voltage by  $\sqrt{3}$  or 1.71. This value is equal to the peak value of the voltage under operating conditions!  
 Example: 15kV cable, 8.7kV to ground AC rms,  $\times 1.41 = 12.27kV$  DC*

Proceed as follows to perform a HIPOT test:

Step	Description		
1	Select the  menu item from the main menu or from the  submenu (depends on the system configuration).		
2	Adjust the test voltage and select  to confirm the value if on manual voltage control.		
3	Press the green illuminated "HV ON" button  .		
4	Select  to start the test (only if <b>AUTOMATIC VOLTAGE RELEASE</b> option is set to <b>Manual</b> . See section "System Settings" on page 24).  <b>Result:</b> The selected voltage is applied to the cable.  During the rise of the voltage the maximum current of the HVPS will be displayed till the cable has been fully charged, at which time the current will drop down to the actual leakage current level. The insulation resistance is displayed. This scenario is observed if the cable has no insulation breakdown, otherwise the high voltage will be shut off when the flashover / breakdown occurs.  Depending on whether a breakdown takes place during the test, <i>one of the following</i> results is presented in the display:		
	<table border="1" style="width: 100%;"> <tr> <td style="width: 20%;"><b>Breakdown at...kV</b></td> <td>A voltage breakdown took place at the indicted test voltage, meaning there was a flash-over at the fault</td> </tr> </table>	<b>Breakdown at...kV</b>	A voltage breakdown took place at the indicted test voltage, meaning there was a flash-over at the fault
<b>Breakdown at...kV</b>	A voltage breakdown took place at the indicted test voltage, meaning there was a flash-over at the fault		

Step	Description	
	<b>No Flash-over</b>	The cable has withstood the applied DC test voltage. In this case no current will be indicated. <i>If required</i> , repeat  the test with higher voltage (do not exceed the maximum permissible voltage)
	<b>Cable not chargeable</b>	The cable could not be charged while the test voltage was applied. This is typically caused by a short circuit condition in the cable (zero voltage and max current),
	<b>Low resistance at ...kV .....MΩ</b>	The HV source cannot charge the cable beyond the indicated voltage value due to a substantial leakage current level; this indicates a very low resistance fault (some voltage and high current) The voltage indication <u>must not</u> be interpreted as a flash-over voltage, it is merely the voltage that the HVPS can build given the high leakage current.
5	Select  to proceed with fault pre-location or  to return to the main menu.	



## How to Pre-Locate the Fault

### Arc Reflection Method (ARM)





For pre-location of a high resistance MV cable fault the EZ-Thump Models, typically the 12kV model, apply the widely approved and well-known ARM (Arc Reflection Method).









Locating the fault is accomplished by comparing a reflection image (impedance) taken with a LV pulse (reference trace) to a reflection image (impedance) taken while an arc, ignited by sudden discharge of the charged capacitor, was present at the fault location (fault trace). With this method, the two measured traces diverge at the position, where the arc caused a negative reflection (impedance change) of the TDR pulse, indicating the fault location.

Proceed as follows to pre-locate the cable fault:

Step	Description
1	<p>Select the LOCATE  menu item from the main screen or from the  submenu screen (depends on the system configuration).</p> <p><b>Result:</b> A LV pulse is applied to the cable. The reflection image with the determined distance to the <i>cable end</i> is presented in the display.</p> <p><b>Cable end most likely at 950ft</b></p>  <p>This reference trace is also called the “live” trace as it is permanently refreshed (blue color vs a black color trace indicating a “frozen” or “saved” LV trace).</p>

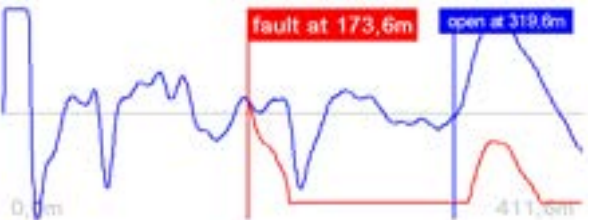

Step	Description
	<p><i>NOTE: The software provides its best estimate for the cable end. <u>If the trace does not show beyond the flag “open at 950 ft” any significant upwards or downwards reflection, then click to confirm. If there is a substantial reflection beyond this point, turn the rotary to the  , click and adjust the end marker manually to where the end of the cable is visible, then click to save and confirm.</u></i></p> <p><i><b>Either the suggested or the manually adjusted cable end <u>must be confirmed</u>, otherwise unit cannot display any distances because it is missing a reference point.</b></i></p>
	<p>In case the software <b>cannot determine</b> the end of the cable, a message will be displayed stating “CABLE END NOT CLEARLY VISIBLE” and will automatically suggest a “manual adjustment”. The manual adjustment of the End Marker is performed by activating the END MARKER icon in the feature menu. After adjusting the end marker to identify the cable end manually, click again and acknowledge the manually identified cable end.</p> <p><b>The SW requires a defined cable end as a reference, otherwise no distances can be shown</b></p> <div style="display: flex; justify-content: space-around;"> <div data-bbox="402 1024 776 1331"> <p>Cable end not clearly visible</p>  </div> <div data-bbox="776 1024 1117 1331"> <p>Cable end not clearly visible</p>  </div> </div>
<p>2</p>	<p>Select  to start fault trace (fault pre-location).</p> <div data-bbox="418 1436 1065 1856">  </div>

Step	Description
3	If required, the surge voltage <i>can be adjusted</i> via the  icon, otherwise, the maximum surge voltage is automatically used, <i>if</i> AUTOMATIC VOLTAGE CONTROL <i>has been selected as default</i> .
4	Press the green illuminated “HV ON” button  .
5	<p>Select  to charge the capacitor (only if AUTOMATIC HIGH VOLTAGE RELEASE option is set to <b>Manual</b>. See page 18).</p> <p><b>Result:</b> The surge capacitor is charged to the max. kV of the specific EZ-Thump Model when set-up for AUTOMATIC VOLTAGE CONTROL <i>and</i> if no adjustment per step 3 has been made</p>
6	<p>Select  to discharge the capacitor (only if AUTOMATIC HIGH VOLTAGE RELEASE option is set to <b>Manual</b>. See page 18).</p> <p><b>Result:</b> A capacitor discharge (shot) is initiated.</p> <p>If a breakdown / flashover takes place, the red fault trace typically has a strong negative reflection. The <i>red fault marker flag</i> is automatically set to the position where both traces diverge from each other (largest difference in impedance).</p>  <div style="border: 1px solid black; padding: 10px; margin-top: 10px;"> <p><b>NOTE:</b> <i>If no trigger is received, no fault trace (red) will be shown. Repeat the procedure with a higher surge voltage (if possible) by selecting the  menu item.</i></p> <p><i>If the blue trace (TDR trace) and the red trace are either 100% matching or following each other very closely, the trigger has been activated, however no breakdown/flashover was detected - increase (➡) voltage <u>or</u> possibly good cable.</i></p> </div>
7	If necessary, adjust the display settings, TDR settings and marker position through the  menu in order to identify the fault distance as precisely as possible.
8	Select  to proceed with pinpointing or  to return to the main screen.







## Current Decoupling (ICE) NOT AVAILBALE IN THE EZ-THUMP Family

### How to Pinpoint a High Resistance (Flash-over) Fault

The thumping mode can be used to pinpoint a high resistance fault between a phase conductor and the neutral conductor of a MV cable. between two phase conductors of a „belted“ MV cable, between 2 phase conductors of a LV cable or between the phase conductor and earth ground of a LV cable.

The EZ-THUMP models provide an internal surge generator to continuously feed high voltage pulses into the defective cable, producing a flashover (arcing) at the fault position. The fault can either be pinpointed using a magnetic / acoustic coincidence detector for best results or a simple acoustic detector with distinct and well understood limitations. The criterion for pinpointing with a simple acoustic detector is the greatest loudness of the flashover noise at the fault location, or, in the case of a magnetic / acoustic coincidence measurement, the smallest propagation time difference between speed of light and speed of sound, where it is not the loudest sound, but the first after receiving magnetic signal. The latter one is more accurate and can be used in all high resistance fault situations (e.g. Megger Digiphone Plus) and **even for pinpointing faults in conduit.**

Proceed as follows to pinpoint the fault:

Step	Description
1	Select the  icon item from the main screen or from the  submenu (depends on the system configuration).
2	Adjust the surge voltage and select  to confirm the value.
3	Press the green illuminated “HV ON” button  .
4	Select  to start the thumping mode (only if AUTOMATIC VOLTAGE RELEASE option is set to <b>Manual</b> , See page 23)  <b>Result:</b> The capacitor is charged up and a discharge takes place after 5 seconds or, if the charging takes longer, right after the selected surge voltage has been reached.  This process is then repeated until thumping is manually stopped.  If required, the surge voltage can be adjusted by selecting the  icon.
5	Pinpoint the fault within the pre-located area with a surge wave receiver like the Megger Digiphone Plus.  For detailed instructions, please refer to the user manual of the surge wave receiver.
6	Select  to stop thumping.

## Detecting a Sheath Fault in a shielded Medium Voltage Cable or a Ground Fault in an Unshielded, Low Voltage Cable (both must be directly buried)

**NOTE:** *The methods described to detect and pinpoint sheath faults in shielded power cables or ground faults in un-shielded cables requires that in both situations the faulted cables are direct buried and not installed in any type of conduit, either PVC conduit or metal type conduit.*

### IMPORTANT

In contrast to the connection diagram on page 15 the HV Output lead has to be connected to the cable shield (concentric neutral) *which in turn has to be disconnected from the common bonding point on both ends* of the specific cable to be tested. Consequently, the HV return lead has to be connected directly to the system ground or a separately driven ground rod.











Fault locating on *unshielded, direct buried low voltage cables* must be carried out in the sheath fault locating mode in order to ensure that the maximum voltage is limited to 5kV; in this case the HV output cable is connected to the center conductor and the HV return to a driven ground rod.



The insulation of any high or medium voltage shielded power cable is protected from water ingress by a jacket made from XLPE or PVC. The Sheath test checks *if* the integrity of the jacket has been compromised, typically during installation.

With a sheath test the dielectric strength of the cable jacket can be tested by applying a DC voltage of up to 5 kV between the cable shield (concentric neutral) and ground. Any leakage indicates a fault in the jacket.

Proceed as follows to perform a sheath test:









Step	Description								
1	Select the  menu item from the  submenu.								
2	Confirm the following two notices with  .								
3	Adjust the test voltage and select  to confirm the value.								
4	Press the green illuminated “HV ON” button  .								
5	Select  to start the test (only if <b>AUTOMATIC VOLTAGE RELEASE</b> option is set to <b>Manual</b> . See “System Settings on page 24).								
	<p><b>Result:</b> The selected voltage is applied to the cable shield.</p> <p>During the rise of the voltage the maximum current of the HVPS will be displayed till the cable has been fully charged, at which time the current will drop down to the actual leakage current level. The insulation resistance is displayed. This scenario is observed if the cable has no insulation breakdown, otherwise the high voltage will be shut off when the flashover / breakdown occurs.</p> <p>Depending on whether a breakdown takes place during the test, one of the following results is presented in the display:</p>								
	<table border="1"> <tr> <td><b>Breakdown at ... kV</b></td> <td>A voltage breakdown took place at the indicted test voltage.</td> </tr> <tr> <td><b>No Flash-over</b></td> <td>The cable jacket has withstood the applied DC test voltage. The test can be repeated using the  menu item.</td> </tr> <tr> <td><b>Cable not chargeable</b></td> <td>The cable shield could not be charged with the test voltage. This is caused by a short in the circuit (fault in the jacket).</td> </tr> <tr> <td><b>Low resistance at ... kV..... MΩ</b></td> <td>The HV source cannot charge the cable beyond the indicated voltage value due to a substantial leakage current level; this indicates a very low resistance fault (some voltage and high current) The voltage indication <i>must not</i> be interpreted as a flash-over voltage, it is merely the voltage that the HVPS can build given the high leakage current.</td> </tr> </table>	<b>Breakdown at ... kV</b>	A voltage breakdown took place at the indicted test voltage.	<b>No Flash-over</b>	The cable jacket has withstood the applied DC test voltage. The test can be repeated using the  menu item.	<b>Cable not chargeable</b>	The cable shield could not be charged with the test voltage. This is caused by a short in the circuit (fault in the jacket).	<b>Low resistance at ... kV..... MΩ</b>	The HV source cannot charge the cable beyond the indicated voltage value due to a substantial leakage current level; this indicates a very low resistance fault (some voltage and high current) The voltage indication <i>must not</i> be interpreted as a flash-over voltage, it is merely the voltage that the HVPS can build given the high leakage current.
	<b>Breakdown at ... kV</b>	A voltage breakdown took place at the indicted test voltage.							
	<b>No Flash-over</b>	The cable jacket has withstood the applied DC test voltage. The test can be repeated using the  menu item.							
<b>Cable not chargeable</b>	The cable shield could not be charged with the test voltage. This is caused by a short in the circuit (fault in the jacket).								
<b>Low resistance at ... kV..... MΩ</b>	The HV source cannot charge the cable beyond the indicated voltage value due to a substantial leakage current level; this indicates a very low resistance fault (some voltage and high current) The voltage indication <i>must not</i> be interpreted as a flash-over voltage, it is merely the voltage that the HVPS can build given the high leakage current.								
6	Select  to proceed with sheath fault pinpointing or  to return to the main menu.								

## How to Pinpoint a Sheath Fault in a Shielded Medium Voltage cable or a Ground Fault in an Unshielded Low Voltage Cable (both must be directly buried)

A failed sheath test (see page 39) is followed by fault locating the sheath fault (in direct buried cables). The test method is based on the step voltage method (earth gradient method) and can be performed with any EZ-Thump serving as HV pulse generator (limited to a max. 5kV voltage, see below). An additional receiver is required to read the strength and polarity of the earth gradient voltage (e.g. Megger ESG-NT or Digiphone+2) in order to pinpoint the sheath fault.

When approaching the fault position, the step voltage increases quickly and decreases to a zero reading directly over the fault and then will swing to a strong voltage of the opposite polarity when going past the fault.

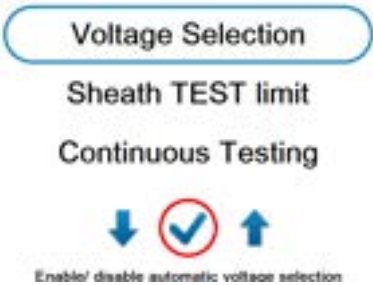
Proceed as follows to pinpoint the sheath fault:

Step	Description
1	Select the  menu item from the  submenu.
2	Confirm the following two notices with  .
3	Adjust the surge voltage and select  to confirm the value.
4	Press the green illuminated "HV ON" button  .
5	Select  to start the sheath fault pinpointing mode. The <b>Voltage Selection, Automatic</b> should be disabled (see page 5 allowing to select a voltage between 0.1 and 5kV). <div style="text-align: center; margin: 10px 0;">  </div> <p><b>Result:</b> The capacitor is charged up and a discharge takes place after 4 seconds injecting a pulsed voltage signal into the cable.</p> <p>This process is then repeated until the process is manually stopped.</p> <p>If required, you can adjust the pulse voltage by selecting the  menu item.</p>
6	Pinpoint the sheath fault with an earth fault locator like the Megger ESG-NT. For detailed instructions, please refer to the user manual of the earth fault locator.
7	Select  to stop pulsing.



# 6

## CUSTOMIZE TDR FEATURES (applicable to TDR and ARM Mode)

### *Introduction*

As soon as a trace has been recorded and is shown on the display, the operator can access up to 20 TDR Features in order to optimize the trace and display settings. The system configuration allows the user to display each of the 20 features as one of 3 categories, which can be individually selected by user for both modes of operation, QUICK STEPS and EXPERT MODE:

*DISABLED* , not available to user by choice))

*ENABLED*, available to user by choice, activated by pushing the  icon  
*EXTENDED OPTIONS* , which are activated by clicking on the 

*Enabled options*, easily available as icons, are placed along the bottom of the screen.

*Extended options* are available from a scroll down sub menu (typically not accessed and used very often).







**NOTE:** *The selection of available features depends on the system configuration and the active user mode. All TDR features are configurable by the customer to best fit his requirements in both Quick Steps mode and Expert Mode.*

*In general, the majority of features listed will be made available when working in **EXPERT MODE** (see page 43); while in **QUICK STEPS MODE** typically only a selection of the most basic features is offered.*









*For detailed information on how to adjust the selection of available features according to the customer's needs (for both modes, see page 43).*

## Customized TDR Features

The following table lists and describes all TDR features included in the system

Menu item	Description
 <p><b>Adjust Gain</b></p>	<p>Adjusts the gain setting. By doing so, the amplification of the received signal and, thus, the amplitude of the Y-axis can be adjusted.</p> <p>With an adjustment of the gain setting, the fault trace, if present, is erased and a new “live” trace is immediately recorded.</p> <div style="border: 1px solid black; padding: 5px; margin: 10px 0;"> <p><i>NOTE: The unit adjusts the gain automatically; however, the operator can override and set his own gain. Too much or too little gain makes the interpretation of the trace impossible!</i></p> </div>
 <p><b>Change visible range</b></p>	<p>Changes the displayed range. By doing so, the trace can be zoomed in and out.</p>
 <p><b>Change value of Cable Velocity</b></p>	<p>Allows manual adjustment of the velocity of propagation. While changing the velocity, the distance values (X-axis scaling) are immediately refreshed and adapted.</p> <p>This menu option is only effective if the <b>Rate</b> parameter is set to <b>Meter</b> or <b>Feet</b>. See page 19.</p> <p>You may either manually adjust the value or automatically adopt the value by identifying /selecting a cable from the cable list. See page 21.</p>
 <p><b>Set / Move Cursor</b></p>	<p>Changes the cursor position. By doing so, the distance value for any point on the trace (typically to the fault) can be obtained.</p> <p>You can also use the cursor to scroll along the X-axis in zoomed view.</p> <p>At first, a coarse adjustment is made and confirmed by pressing the rotary knob  once - subsequently, the position can be fine-tuned.</p>
 <p><b>Adjust the End Marker</b></p>	<p>Allows the manual adjustment of the blue end marker.</p> <p>At first, a coarse adjustment is made and confirmed by pressing the rotary knob  once - subsequently, the position can be fine-tuned.</p>



Menu item	Description						
 <p><b>Copy trace, makes copy of live trace when superimposing several traces</b></p>	<p>Makes an exact copy (blue trace) of the “live” trace.</p> <div style="border: 1px solid black; padding: 10px; margin: 10px 0;"> <p><i>NOTE: This function is very helpful when making a phase comparison on 3 phase MV circuits.</i></p> <p><i>It is also very helpful when just using the TDR function on low voltage cables with 3 or 4 conductor cables and by comparing them. Typically, this will show the location of the fault in one of the conductors, provided the fault is either an “OPEN” or a “SHORT” or shows an impedance change when compared to another impedance of the cable.</i></p> </div>						
 <p><b>Set Marker at Current Cursor Position</b></p>	<p>Places an additional marker (green) at the cursor position (red). <b>As only one additional marker can be placed, the very last marker is erased every time the marker is placed on a new position.</b></p>						
<p><b>Save Current Trace</b></p>	<p>Saves the current screen view to the internal memory.</p>						
<p><b>Export, Recall or Delete Stored Traces</b></p>	<p>Enables you to export, recall and delete stored data from internal memory.</p> <p>By selecting <b>All traces</b>, you can delete or export all traces which are currently stored in the internal memory.</p> <p>In case you want to select a specific trace, you need to select the recording date first. You are then allowed to scroll through preview pictures of all traces stored on this day.</p> <p>After you selected the desired trace(s), you can choose from the following options:</p> <table border="1" data-bbox="514 1350 1430 1839"> <tbody> <tr> <td data-bbox="514 1350 683 1566"><b>Export</b></td> <td data-bbox="683 1350 1430 1566"> <p>Copies the selected trace(s) to the <i>EtrayTraces</i> folder on the USB flash drive which has been plugged into the USB slot .</p> <p>The data can be viewed in any regular web browser by opening the <i>index.html</i> file which is also located in the <i>EtrayTaces</i> folder.</p> </td> </tr> <tr> <td data-bbox="514 1566 683 1629"><b>Remove</b></td> <td data-bbox="683 1566 1430 1629"> <p>Removes the selected trace(s) from internal memory.</p> </td> </tr> <tr> <td data-bbox="514 1629 683 1839"><b>Recall</b></td> <td data-bbox="683 1629 1430 1839"> <p>Displays the selected trace on the screen. The screen view can then be adjusted using any function which does not require the trace to be updated.</p> <p>By selecting , the loaded trace is closed, and the last recorded trace is displayed again.</p> </td> </tr> </tbody> </table>	<b>Export</b>	<p>Copies the selected trace(s) to the <i>EtrayTraces</i> folder on the USB flash drive which has been plugged into the USB slot .</p> <p>The data can be viewed in any regular web browser by opening the <i>index.html</i> file which is also located in the <i>EtrayTaces</i> folder.</p>	<b>Remove</b>	<p>Removes the selected trace(s) from internal memory.</p>	<b>Recall</b>	<p>Displays the selected trace on the screen. The screen view can then be adjusted using any function which does not require the trace to be updated.</p> <p>By selecting , the loaded trace is closed, and the last recorded trace is displayed again.</p>
<b>Export</b>	<p>Copies the selected trace(s) to the <i>EtrayTraces</i> folder on the USB flash drive which has been plugged into the USB slot .</p> <p>The data can be viewed in any regular web browser by opening the <i>index.html</i> file which is also located in the <i>EtrayTaces</i> folder.</p>						
<b>Remove</b>	<p>Removes the selected trace(s) from internal memory.</p>						
<b>Recall</b>	<p>Displays the selected trace on the screen. The screen view can then be adjusted using any function which does not require the trace to be updated.</p> <p>By selecting , the loaded trace is closed, and the last recorded trace is displayed again.</p>						

Menu item	Description
<b>Adjust Pulse Width</b>	<p>Allows manual adjustment of the pulse width.</p> <p>Pulse width is automatically selected as a function of cable length. Narrow pulses lead to short ranges but at very high resolution. Wide pulses which provide lower resolution must be used when measuring long cables.</p> <p>With an adjustment of the pulse width, the fault trace, if present, is erased and a new "live" trace is immediately recorded.</p>
<b>Change transformer sensitivity</b>	<p>Only applicable in combination with the sectionalizing software. Allows manual adjustment of the transformer search sensitivity. Decreasing or increasing the sensitivity has an effect on the number of transformers identified by the software but <b>will not change the position of the transformers</b> relative to each other and the 2 cable ends.</p> <div style="border: 1px solid black; padding: 5px; margin: 10px 0;"> <p><i>NOTE: The sectionalizing method is typically only used in North American URD loop type circuits!</i></p> </div>
<b>Find Transformers in Actual Trace</b>	<p>Allows manual start of the transformer search.</p>
<b>Disable live trace/ Enable live trace</b>	<p>Disables / enables continuous "live" trace recording.</p> <p><u>Typically, it is recommended to have only the "live" trace option activated</u>, which means the trace is always live and any adjustment becomes immediately visible.</p>

## Completing the Operation

After the fault location procedure has been finished switch off the system by pressing the "ON / OFF" button **7**.

The test object is to be grounded and shorted. Afterwards, the unit can be disconnected from the test object in accordance with the safety instructions below:

### WARNING

**F**

Follow the five safety rules described on page 3.

Even if proper disconnection and discharging has taken place, system components which have been under voltage must only be touched, if they have been visibly shorted and grounded beforehand.

Do not undo and or remove grounding and shorting measures until the time when the test object is put into operation again.

# 7

## ADVANCED SYSTEM SETTINGS

### *How to Edit the Cable List*

#### Introduction

Cable lists are XML files which are stored in the internal memory and can be imported and exported (*see page 21*). By default, one cable list with a selection of prevalent cable types is pre-installed on the unit.

#### XML Structure of a Cable List File

The following example shows the XML structure of a cable list:

```
<?xml version="1.0" encoding="utf-8"?>
<cablE list name="Default" version="1">
  <tabledef>
    <column attrName="TYPE">TYPE</column>
    <column attrName="MILS">MILS</column>
    <column attrName="KV">KV</column>
    <column attrName="GAUGE">GAUGE</column>
  </tabledef>
  <cablE>
    <attr name="TYPE">EPR</attr>
    <attr name="MILS">220</attr>
    <attr name="KV">15</attr>
    <attr name="GAUGE">4/0</attr>
    <velocity>
      <value>286</value>
      <unit>feet/μs</unit>
    </velocity>
  </cablE>
  ...
</cablE list>
```

While the **bolded parts must not be changed**, there can be an arbitrary number of `< cable >` elements placed one after another each presenting a cable type.

The `< cable >` element consists of the following mandatory and optional child elements:

<code>&lt;attr name="TYPE"&gt;</code>	Cable type (mandatory / unique)
<code>&lt;attr name="MILS"&gt;</code>	Area of the cable type (e.g. in kcmil or mm <sup>2</sup> ) (optional)
<code>&lt;attr name="KV"&gt;</code>	Rated voltage of the cable (optional)
<code>&lt;attr name="GAUGE"&gt;</code>	Diameter of the cable type (e.g. American wire gauge value) (optional)
<code>&lt;velocity&gt;</code>	
<code>&lt;value&gt;</code>	Value of the propagation velocity ( <b>mandatory</b> )
<code>&lt;unit&gt;</code>	Unit of the propagation velocity in <b>feet/μs</b> or <b>m/μs</b> ( <b>mandatory</b> )
<code>&lt;/velocity&gt;</code>	

### How to Edit the Cable List (XML Structure)

*NOTE: Editing cable lists requires basic knowledge of the Extensible Markup Language (XML) standards. By altering the structure of the XML file during edit, the cable list would be rendered unreadable and useless.*

Proceed as follows to adapt the list to your needs:



Step	Action
1	Export the standard cable list to a USB flash drive (see page 21).
2	Open the XML document using a text editor with XML syntax highlighting (e.g., Notepad++).
3	You can now add new cable types by adding new <code>&lt; cable &gt;</code> elements to the file (see previous page). You may also change or remove existing <code>&lt; cable &gt;</code> elements.
4	Save the new cable list in the <i>CableLists</i> folder of the USB drive.

Step	Action
5	Import the new cable list into the unit. See page 21.
6	Set the new cable list as default cable list. See page 21.

## How to Setup Customer-Specific TDR Features

Thanks to the high level of configurability of the E-TRAY interface, the EZ-THUMP allows for the TDR features in both, "EXPERT MODE" *and* "QUICK STEPS MODE", (see page 18) to be *customer configurable*, provided the TDR setting in the DEFAULT section is in AUTOMATIC

In order to create your own customer-specific settings, proceed as follows:

Step	Action	
1	Enable the EXPERT MODE. See page 19.	
2	Access the expert settings via the  menu item.	
3	Select the <b>Customize TDR Features</b> menu item.	
4	Select the <b>Setup options</b> menu item.	
5	<i>If you want to change the options of the <b>QUICK STEPS mode</b>...</i>	<i>If you want to change the options of the <b>EXPERT MODE</b>...</i>
	... select the <b>QUICK STEPS</b> menu item.	... select the <b>Expert</b> menu item.
6	Select the option you want to activate / deactivate. An overview table of all options can be found in appendix 1.	
7	Select one of the available options by rotating the rotary knob  :	
	<b>Disabled</b>	The option is not available in the selected user mode.
	<b>Simple</b>	The option is available in the <i>Standard Options</i> menu of the selected user mode.
	<b>Extended</b>	The option is available in the <i>Extended Options</i> menu of the selected user mode.

Step	Action
8	Confirm the selection with  .
9	If required, perform steps <b>6</b> to <b>8</b> for further options.
10	The adjusted configuration can be shared among your units using the <b>Export</b> and <b>Import</b> functions of the <b>Menu Locate Options</b> menu.

## ***How to Use EasyPROT Software to Plot DC HIPOT/Sheath Test Data***

The EZ-THUMP 3/4/12KV MODELS allows recording and graphing of DC test data, either DC HIPOT test data or Sheath test data. Before switching the EZ-Thump on, insert USB drive into front panel. Then start the unit and conduct the particular test. After the test is finished, operator will be asked if he or she wants to export data. By clicking yes a *.csv* data set is written to the USB drive. It can be downloaded on to a laptop, which has the EasyPROT software installed. The EasyPROT software is available as an option for all E-TRAY products.

# 8

## CARE and MAINTENANCE

### *Maintenance*

For installation and operation of the equipment it is not necessary to open the enclosure of the instrument. Opening the enclosure will void the warranty and liability of the manufacturer.

Connections and connectors must be tested according to all applying standards (international, national and company own). Keep connectors and connections clean.

Line and neutral on the AC power input are fused. The fuses are only accessible on the inside of the unit!

### *Storage*

If not in use, the system should be stored in a dust free and dry environment. Humidity (condensation) by itself or in combination with dust can reduce critical distances within the equipment, which are necessary to maintain safe high voltage performance.

Always store the unit at a full state-of-charge. Apply topping charge every six months.



M

# Appendix 1

## Overview of TDR Features

See next page for complete chart.

Option	Recommended settings	Your settings (mark with x)					
		QUICK STEPS mode			EXPERT MODE		
		Disa.	Simp.	Ext.	Disa.	Simp.	Ext.
<b>Cable Velocity</b> (option to adjust the cable velocity)	QUICK STEPS: <b>simple</b> Expert: <b>simple</b>						
<b>Xfmr sensitivity</b> (option to adjust the transformer sensitivity)	QUICK STEPS: <b>disabled</b> Expert: <b>simple</b>						
<b>Delay time</b> (option to adjust the trigger delay time, Single Shot units only)	QUICK STEPS: <b>disabled</b> Expert: <b>extended</b>						
<b>Disable live Trace</b> (option to disable live trace recording, not recommended)	QUICK STEPS: <b>disabled</b> Expert: <b>extended</b>						
<b>Graphic View</b> (option to enable the graphical view)	QUICK STEPS: <b>disabled</b> Expert: <b>disabled</b>						
<b>Enable live Trace</b> (option to enable live trace recording)	QUICK STEPS: <b>disabled</b> Expert: <b>extended</b>						
<b>Alphanumeric View</b> (option to enable the alphanumeric view, not recommended))	QUICK STEPS: <b>disabled</b> Expert: <b>disabled</b>						
<b>Opt Gain</b> (for service purposes only)	---	---	---	---	---	---	---
<b>Search for For</b> (option to start a transformer search)	QUICK STEPS: <b>disabled</b> Expert: <b>simple</b>						
<b>Gain</b> (option to adjust the gain setting)	QUICK STEPS: <b>simple</b> Expert: <b>simple</b>						
<b>Put Trace on hold</b> (option to put live trace on hold)	QUICK STEPS: <b>simple</b> Expert: <b>simple</b>						
<b>Adjust End Marker</b> (option to adjust the end marker)	QUICK STEPS: <b>simple</b> Expert: <b>simple</b>						
<b>Adjust Start Marker</b> (option to adjust the start marker)	QUICK STEPS: <b>disabled</b> Expert: <b>extended</b>						
<b>Recall stored Traces</b> (option to export, delete and recall traces)	QUICK STEPS: <b>disabled</b> Expert: <b>simple</b>						
<b>Cursor</b> (option to move the cursor)	QUICK STEPS: <b>simple</b> Expert: <b>simple</b>						
<b>Additional Marker</b> (option to place an additional marker)	QUICK STEPS: <b>disabled</b> Expert: <b>simple</b>						
<b>Pulse width</b> (option to adjust the pulse width)	QUICK STEPS: <b>disabled</b> Expert: <b>simple</b>						
<b>Save trace</b> (option to save the current trace)	QUICK STEPS: <b>simple</b> Expert: <b>simple</b>						
<b>Save Fulltrace to USB</b> (for service purposes only)	---	---	---	---	---	---	---
<b>Zoom In/Out</b> (option to zoom the trace in and out)	QUICK STEPS: <b>simple</b> Expert: <b>simple</b>						